

# EUROPEAN TECHNICAL ASSESSMENT

**ETA 15/0509**  
Version 01  
Date of issue: 2016-12-16



UBAtc Assessment Operator:  
Belgian Construction Certification Association  
Rue d'Arlon 53 - 1040 Brussels  
www.bcca.be - info@bcca.be



Technical Assessment Body issuing the European Technical Assessment: UBAtc.  
UBAtc has been designated according to Article 29 of Regulation (EU) No 305/2011  
and is member of EOTA (European Organisation for Technical Assessment)

**Trade name of the  
construction product:**

Piterak Slim & Piterak XS

**Product family to which the  
construction product belongs:**

Wall cladding kit

**Manufacturer:**

Terreal, 15 Rue Pagès, 92158 Suresnes Cedex (France)

**Manufacturing plant(s):**

Soladriho, Est. da Barroca, Apartado 54,  
2334-909 Entroncamento (Portugal)

**Website:**

www.terrealfacade.com

**This European Technical  
Assessment is issued in  
accordance with Regulation  
(EU) N° 305/2011, on the basis  
of:**

Guideline for European technical approval (ETAG), used as  
European Assessment Document (EAD): 034-1

**This European Technical  
Assessment contains:**

15 pages, including 2 Annex(es) which form an integral part  
of the document



European Organisation  
for Technical Assessment

## I. Legal bases and general conditions

- 1 This European Technical Assessment is issued by UBAtc (Union belge pour l'Agrément technique de la construction, i.e. Belgian Union for technical Approval in construction), in accordance with:
  - Regulation (EU) N° 305/2011<sup>1</sup> of the European Parliament and of the Council of 9 March 2011 laying down harmonised conditions for the marketing of construction products and repealing Council Directive 89/106/EEC
  - Commission Implementing Regulation (EU) N° 1062/2013<sup>2</sup> of 30 October 2013 on the format of the European Technical Assessment for construction products
  - Guideline for European technical approval (ETAG), used as European Assessment Document (EAD): ETAG 034-1
- 2 Under the provisions of Regulation (EU) N° 305/2011, UBAtc is not authorized to check whether the provisions of this European Technical Assessment are met once the ETA has been issued.
- 3 The responsibility for the conformity of the performances of the products with this European Technical Assessment and the suitability of the products for the intended use remains with the holder of the European Technical Assessment.
- 4 Depending on the applicable Assessment and verification of constancy of performance (AVCP) system, (a) notified body(ies) may carry out third-party tasks in the process of assessment and verification of constancy of performance under this Regulation once the European Technical Assessment has been issued.
- 5 This European Technical Assessment allows the manufacturer of the construction product covered by this ETA to draw up a declaration of performance for the construction product.
- 6 CE marking should be affixed to all construction products for which the manufacturer has drawn up a declaration of performance.
- 7 This European Technical Assessment is not to be transferred to other manufacturers, agents of manufacturers, or manufacturing plants other than those indicated on page 1 of this European Technical Assessment.
- 8 The European Technical Assessment holder confirms to guarantee that the product(-s) to which this assessment relates, is/are produced and marketed in accordance with and comply with all applicable legal and regulatory provisions, including, without limitation, national and European legislation on the safety of products and services. The ETA-holder shall notify the UBAtc immediately in writing of any circumstance affecting the aforementioned guarantee. This assessment is issued under the condition that the aforementioned guarantee by the ETA-holder will be continuously observed.
- 9 According to Article 11(6) of Regulation (EU) N° 305/2011, when making a construction product available on the market, the manufacturer shall ensure that the product is accompanied by instructions and safety information in a language determined by the Member State concerned which can be easily understood by users. These instructions and safety information should fully correspond with the technical information about the product and its intended use which the manufacturer has submitted to the responsible TAB for the issuing of the European Technical Assessment.
- 10 Pursuant to Article 11(3) of Regulation (EU) N° 305/2011, manufacturers shall adequately take into account changes in the product-type and in the applicable harmonised technical specifications. Therefore, when the contents of the issued European Technical Assessment do not any longer correspond to the product-type, the manufacturer should refrain from using this European Technical Assessment as the basis for their declaration of performance.
- 11 All rights of exploitation in any form and by any means of this European Technical Assessment is reserved for UBAtc and the ETA-holder, subject to the provisions of the applicable UBAtc regulations.
- 12 Reproduction of this European Technical Assessment including transmission by electronic means shall be in full. However, partial reproduction can be made with the written consent of UBAtc. In this case partial reproduction has to be designated as such. Texts and drawings of advertising brochures shall not contradict or misuse the European Technical Assessment.
- 13 Subject to the application introduced, this European Technical Assessment is issued in English and may be issued by the UBAtc in its official languages. The translations correspond fully to the English reference version circulated in EOTA.
- 14 This European Technical Assessment was first issued by UBAtc on: 16/12/2016.

---

<sup>1</sup> OJEU, L 88 of 2011/04/04

<sup>2</sup> OJEU, L 289 of 2013/10/31

## II. Technical Provisions

### 1 Technical description of the product

#### 1.1 General

The subject of the ETA is a cladding kit, consisting of cladding tiles, intended to be attached to a substructure, and its fixing products.

The kit comprises:

- Cladding terracotta tiles with several dimensions (manufactured to order, within a particular size range, see Table 1 and Figure 1) and several colours and surface textures, with and without finishing.
- Several fixing elements:
  - Screws and clips; and
  - Supporting frame, consisting of rails

The kit does not comprise the mechanical fixing(s) (system) to fasten the supporting frame to the loadbearing structure, windows, doors and thermal insulation products. If insulation products are used in the assembly, then these shall to be in accordance with Annex 2.

The cladding tiles may also be used without the other kit components, using clips, screws, rails and brackets purchased on the market by the users.

The provisions made in this European Technical Assessment are based on an assumed intended working life of 25 years.

Indications given regarding the working life cannot be interpreted as a guarantee given by the producer or the UBAtc, but are to be regarded only as a means for choosing the appropriate product(s) in relation to the expected economically reasonable working life of the construction works.

#### 1.2 Kit components

##### 1.2.1 Cladding terracotta tiles

The cladding tiles have the trade names Piterak Slim (nominal thickness 30 mm) and Piterak XS (nominal thickness 18 mm). The tiles are manufactured from a homogeneous mixture of natural clay, selected additives or colour pigments and water. The tiles are pressed, dried and controlled.

**Table 1: The range of terracotta tiles for each trade name**

Denomination	Nominal thickness [mm]	Length [mm]	Height [mm]	Mass [kg/m <sup>2</sup> ]
Piterak Slim	30	300 - 1520	150 - 600	48,5
Piterak XS	18	300 - 1500	150 - 400	30
tolerances	± 1	± 2	± 2,5	

The most occurring colours are listed in table 2.

**Table 2: The most occurring colours:**

Reference	Colour	Reference	Colour
1	Red	10	Chalk white
2	Red orange	11	Sahara beige
3	Champagne	12	Light grey
4	Salmon	13	Storm grey
6	Sand	15	Slate grey
7	Sienna	16	Ebony
9	Coffee brown		

The available finish on the front surface are smooth, sanded and glazed and there is a big range of colours. The tiles are placed horizontal with vertical joints.

The cladding elements are usually produced according to a specific technical design for joints and construction discontinuities, according to the product description.

#### 1.2.2 Fixing elements

##### 1.2.2.1 Stainless steel clips

The fixings are "clips in stainless steel", range X5CrNi 18-10, thickness of 15/10<sup>th</sup> mm.

Clips are available in 2 types (see Annex 1, Figure 2):

- **Type standard:** has a height of 65 mm and a width of 75 mm
- **Type above:** for finish on top or for replacements. They have a height of 36,5 mm and a width of 75 mm.

##### 1.2.2.2 Screws

Screws for fixing the clips on the aluminium rails: self-drilling screw, flat head. Minimum dimensions Ø 5,5 mm x 25 mm. Stainless steel A2. Minimum pull-out load P<sub>k</sub>: 1500 N.

##### 1.2.2.3 Aluminium rails

The aluminium rails (see Annex 1, Figure 2) placed on the market by Terreal have a height of 3 m and a thickness of 3 mm and are made of Aluminium brut range EN AW 6060 T6 in accordance with the EN 755-2.

The standard rails have a U-section of 146x46 mm or Y-section of 146x75, the corner rails have a □-section of 69x69 mm.

##### 1.2.2.4 Alternative fixing elements

In case fixing elements are used, which are not placed on the market by Terreal, then these should be in accordance with the requirements specified above.

## 2 Specification of the intended use(s) in accordance with the applicable EAD

Non-loadbearing cladding kit for use as external cladding of vertical walls, mechanically fastened to a framework (not specific to the kit) which is fixed to the external wall of new or existing buildings. An insulation layer is usually fixed on the external wall.

The most critical assembly covered by this ETA, with regards to height and length of tiles and intermediate distance between supports has been specified in clause 3.4.2 of this ETA.

The substrate walls are made of masonry (clay, concrete or stone) or concrete (cast on site or prefabricated), new or in use.

Between the cladding products and the insulation layer or the external wall, if no insulation is used, there should be an air space cavity which is drained and ventilated. The ventilation openings should be suitably protected, or baffled, to prevent rain ingress and vermin access.

The cladding kit does not contribute to the stability of the wall on which it is installed. It contributes to the durability of the works by providing enhanced protection from the effects of weathering, but is not intended to ensure airtightness of the building structure.

This ETA does not include an allowance for acts of vandalism.

## 3 Performance of the product and references to the methods used for its assessment

### 3.1 Mechanical resistance and stability (BWR 1)

The cladding tile has a modulus of rupture  $\geq 15$  MPa in accordance with EN ISO 10545-4.

### 3.2 Safety in case of fire (BWR 2)

#### 3.2.1 Reaction to fire

The cladding kit (front and rear side) has been classified as A1 in accordance with EN 13501-1 in accordance with Commission Decision 96/603/EC of 4 October 1996, as amended<sup>3</sup>.

Since the cladding kit has not been assessed according to façade fire scenarios, an additional demonstration of the fitness for use in this context could have to be given in some countries at national level, as long as the harmonised system is not available.

#### 3.2.2 Fire resistance

Not relevant.

### 3.3 Hygiene, health and the environment (BWR 3)

#### 3.3.1 Watertightness of joints

The kit has open vertical joints. Thus artificial rain tests have not been carried out.

#### 3.3.2 Water permeability

#### 3.3.3 Water vapour permeability

Not relevant.

#### 3.3.4 Drainability

No drainability problems have been revealed from the study of the technical drawings.

#### 3.3.5 Release of dangerous substances

In accordance with a statement issued by the ETA-holder, the product/kit complies with all relevant European and national provisions applicable for the uses for which it is brought to the market. For other uses or other Member States of destination there may be other requirements which would have to be respected. For dangerous substances contained in the product, but not covered by the ETA, the NPD option (no performance assessed) is applicable.

No materials containing flame retardants, formaldehyde, pentachlorophenol, carcinogen man-made mineral fibres, ceramic fibres and/or cadmium are used in the production of the kit components.

### 3.4 Safety in Use (BWR 4)

#### 3.4.1 Wind load resistance

The assessment is based on data from the wind load performance test under static negative air pressures applied to the Terreal wall cladding system.

<sup>3</sup> OJ L 267, 19.10.1996, p.23, amended by Decisions 2000/605/EC of 26 September 2000 and 2003/424/EC of 6 June 2003.

The most critical case was assessed (see Table 3).

The characteristic wind resistance is derived from the pull-out resistance or deformation of the clips. The results of the wind suction test were higher than the pull-out resistance of the fixings.

### 3.4.2 Wind suction

Table 3 – Wind suction tests

Tile Piterak	Height [mm]	Length [mm]	Intermediate distance [mm]	Fraction of tile [Pa]
XS 30 <sup>U</sup>	300	600	600	> 8900
Slim 30 <sup>U</sup>	300	1520	1530	8257
Slim 30 <sup>Y</sup>	600	1600	600	- 5988

<sup>U</sup> mounted on U-profiles      <sup>Y</sup> mounted on Y-profiles

The graphic and points of measurements of the test on the XS 30 mounted on U-profiles are given below:

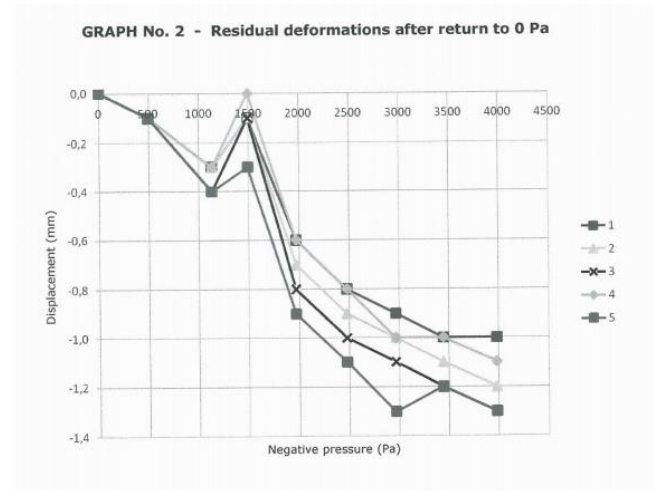
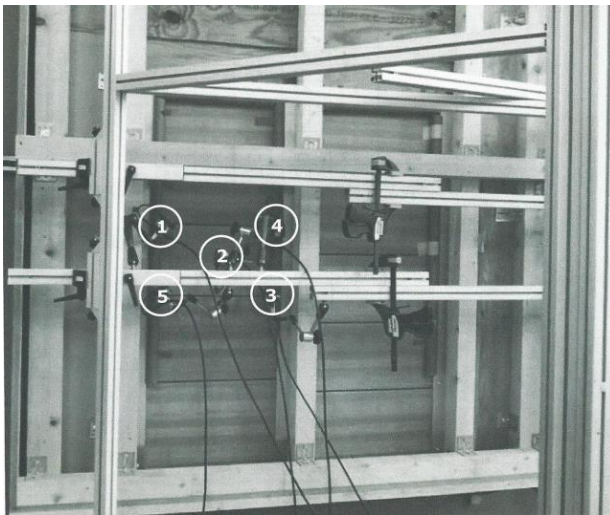

There is no deformation or deflection of the files measured up to a pressure of 8900 Pa.

The graphic and points of measurements of the test on the Slim 30 mounted on U-profiles are given below:

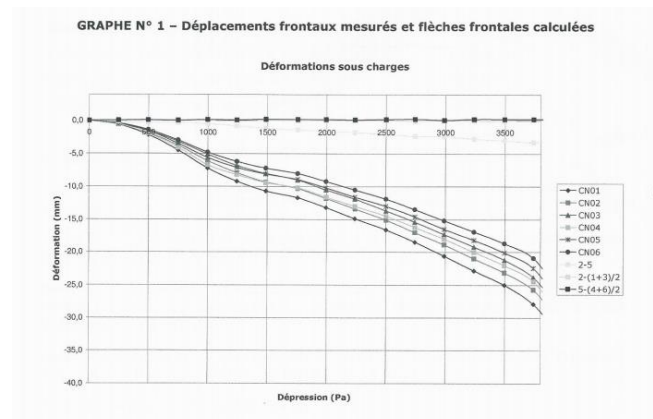
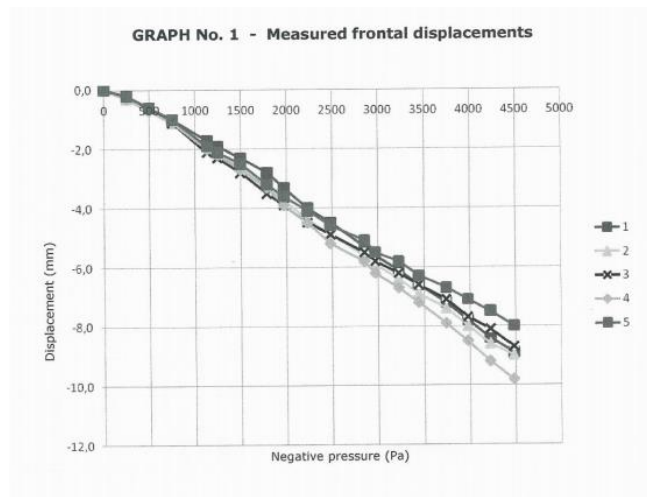
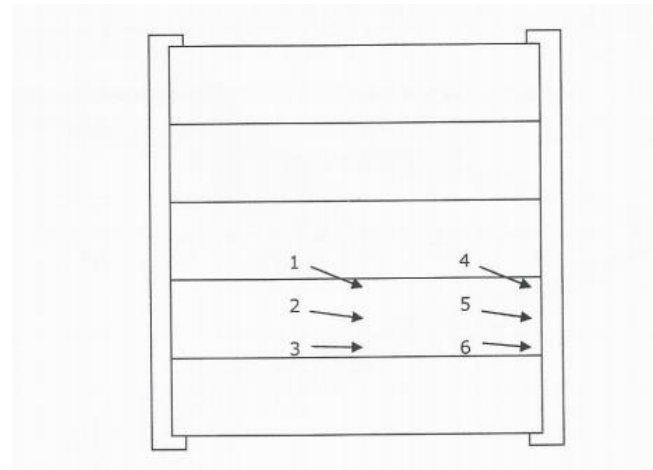

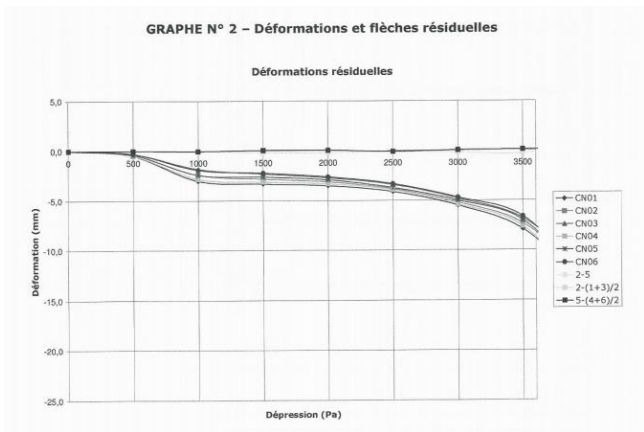

There is no deformation or deflection of the tiles measured up to a pressure of 8257 Pa, the load at which moment the clip deforms and the tile(s) are released from the clips.

The graphic and points of measurements of the test on the Slim 30 mounted on Y-profiles are given below:

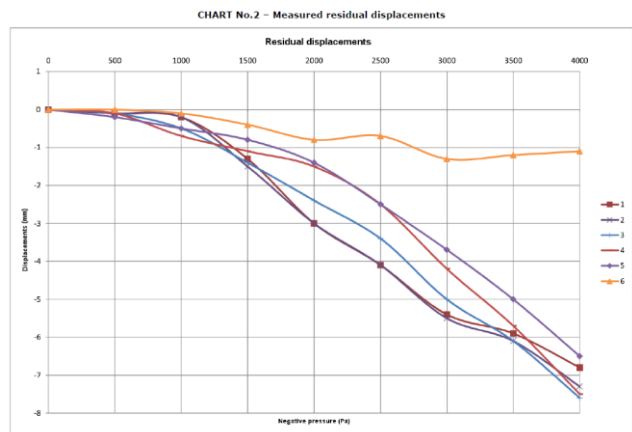
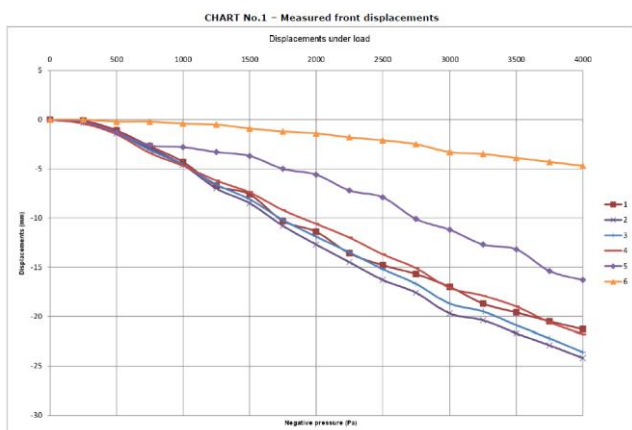
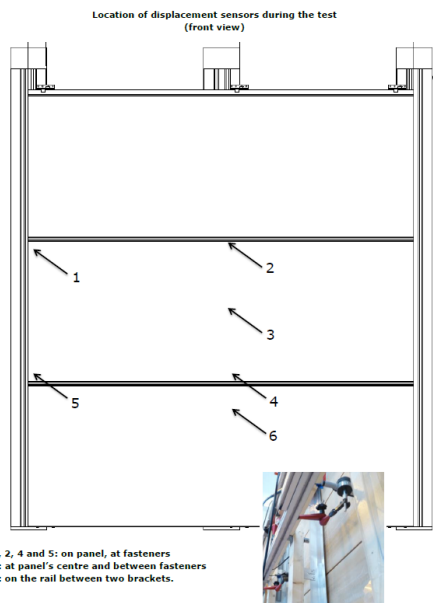

There is no deformation or deflection of the tiles measured up to a pressure of - 5988 Pa, the load at which moment the top clips deform and the tile(s) are released from the clips.

### 3.4.3 Mechanical resistance

#### 3.4.3.1 Family F (metal clips)

##### Mechanical resistance of fixings – clips

Table 4 – Mechanical resistance of fixings - clips

Mounting	Mean and characteristic value [N]
Standard	1256
Top replacement (used for the top row of files)	

#### 3.4.4 Resistance to horizontal point loads

The resistance to horizontal point loads has not been assessed.

#### 3.4.5 Impact resistance – shatter properties

The categories given in the following table correspond to the degrees of exposure in use.

Table 5– Definition of use categories cf. ETAG 034

Use category	Description
I	A zone readily accessible at ground level to the public and vulnerable to hard body impacts but not subjected to abnormally rough use.
II	A zone liable to impacts from thrown or kicked objects, but in public locations where the height of the kit will limit the size of the impact; or at lower levels where access to the building is primarily to those with some incentive to exercise care.
III	A zone not likely to be damaged by normal impacts caused by people or by thrown or kicked objects.
IV	A zone out of reach from ground level

Based upon the obtained test results, the kit (with a maximum intermediate distance of the vertical profiles equal to the length of the tile) is assessed as being in categories II and III.

It has been established that the cladding product does not present sharp or cutting edges and its surfaces do not cause bodily injury, to the occupants or people nearby.



### 3.4.6 Resistance to seismic actions

European and/or National regulation shall be applied.

### 3.4.7 Hygrothermal behaviour

The tiles' hygrothermal behaviour assessment leads to the conclusion that these are not subject to hygrothermal variations, such as:

- Deterioration, such as cracking or delamination of the cladding tile
- Detachment of the cladding element from the clips
- Irreversible deformation

### 3.5 Protection against noise (BWR 5)

Not relevant

### 3.6 Energy economy and heat retention (BWR 6)

Not relevant

### 3.7 Sustainable use of natural resources (BWR 7)

Not relevant

### 3.8 Aspects of durability and serviceability

#### 3.8.1 Pulsating load

The resistance before and after pulsating loads, as well as the displacements recorded during this test, have been cited in paragraph 3.4.2.

#### 3.8.2 Expansion due to moisture

The result of the assessment of the tiles in accordance with EN ISO 10545-9, leads to the conclusion that the expansion due to moisture smaller is than 1,6 mm/m

#### 3.8.3 Immersion in water

The result of the assessment of the tiles in accordance with EN ISO 10545-3, leads to the conclusion that the water absorption smaller is than 9%.

#### 3.8.4 Freeze-thaw

The result of the assessment of the tiles in accordance with EN 539-2:2013, leads to the conclusion that the tiles may be classified as level 1.

#### 3.8.5 Chemical and biological attack

The tile material is not known to be of subject to specific chemical or biological attack.

#### 3.8.6 Corrosion

The tile material is not known to be of subject to corrosion. The stainless alloy of the clips should be adapted to the aggressiveness of the local conditions.

#### 3.8.7 UV radiation

Only mechanical deterioration has been assessed, decorative properties have not been considered. The tiles are resistant to UV.

## 4 Assessment and verification of constancy of performance (AVCP) system applied, with reference to its legal base

In accordance with Regulation (EU) N° 305/2011, Article 65, Directive 89/106/EEC is repealed, but references to the repealed Directive shall be construed as references to the Regulation.

The system(s) of assessment and verification of constancy of performance, specified in the Decision of the Commission 2003/640/EC of 2003-9-4<sup>4</sup>, and Commission Delegated Regulation (EU) 2016/364<sup>5</sup>, are shown in the following Tables.

**Table 6 – System of assessment and verification of constancy of performance applicable to cladding kit**

Product(s)	Intended use(s)	Level(s) or class(es)	Assessment and verification of constancy of performance system(s)*
Kits for exterior wall claddings	For external walls or external finishes of walls	-	2+
<b>* See Annex V to Regulation (EU) N° 305/2011</b>			

**Table 7 – Choice of the system of assessment and verification of constancy of performance to cladding kit with respect to reaction to fire**

Product(s)	Intended use(s)	Level(s) or class(es)	Assessment and verification of constancy of performance system(s)*
Kits for exterior wall claddings	for uses subject to regulations on reaction to fire	A1 (*), A2 (*), B (*), C (*)	1
		A1 (**), A2 (**), B (**), C (**), D, E	3
		(A1 to F) (***), NPD	4
<p>(*) Products/materials for which a clearly identifiable stage in the production process results in an improvement of the reaction-to-fire classification (e.g. an addition of fire retardants or a limiting of organic material).</p> <p>(**) Products/materials not covered by footnote (*).</p> <p>(***) Products/materials that do not require to be tested for reaction to fire (e.g. products/materials of classes A1 according to Commission Decision 96/603/EC, as amended).</p> <p><b>* See Annex V to Regulation (EU) N° 305/2011</b></p>			

<sup>4</sup> see OJEU L226 of 2003-9-10

<sup>5</sup> see OJEU L68/4 of 2016/03/15

## 5 Technical details necessary for the implementation of the AVCP system, as foreseen in the applicable EAD

### 5.1 Tasks for the ETA-holder

#### 5.1.1 Factory production control (FPC)

The ETA-holder shall exercise permanent internal control of the production. All the elements, requirements and provisions adopted by the ETA-holder shall be documented in a systematic manner in the form of written policies and procedures. This factory production control system shall ensure that production is in conformity with this ETA.

The personnel involved in the production process shall be identified, sufficiently qualified and trained to operate and maintain the production equipment. Machinery equipment shall be regularly maintained and this shall be documented. All processes and procedures of production shall be recorded at regular intervals.

The ETA-holder shall maintain a traceable documentation of the production process from purchasing or delivery of raw or basic raw materials up to the storage and delivery of finished products.

The production control system shall specify how the control measures are carried out, and at which frequencies.

ETA-holders which have an FPC system that complies with EN ISO 9001 and that addresses the requirements of this ETA are recognised as satisfying the FPC requirements.

Products that do not comply with requirements as specified in the ETA shall be separated from the conforming products and marked as such. The ETA-holder shall register non-compliant production and action(-s) taken to prevent further non-conformities. External complaints shall also be documented, as well as actions taken.

When materials/products are delivered for incorporation into the production process, verification of conformity with specifications in the ETA shall take place.

If supplied materials/components are not manufactured and tested by the supplier in accordance with agreed methods, or where the ETA-holder purchases materials/components on the open market, then where appropriate, they shall be subject to suitable documented checks/tests by the ETA-holder before acceptance.

The characteristics of incoming material and components, for which the supplier demonstrates documented compliance with a product specification, for an intended use that is appropriate for its use as a raw material or component of the product, shall be considered satisfactory and need, except in justified doubt, no further checking, unless the control plan specifies differently.

#### 5.1.2 Testing of samples taken at the factory

##### 5.1.2.1 General

At least the following minimum information shall be recorded:

- date and time of manufacture
- type of product produced
- material specification
- all results of the verifications performed within the agreed upon control plan

### 5.1.3 Maintenance, checking and calibration of equipment

All testing equipment shall be maintained, calibrated and/or checked against equipment or test specimens traceable to relevant international or nationally recognised reference test specimens (standards). In case no such reference test specimens exist, the basis used for internal checks and calibration shall be documented.

The ETA-holder shall ensure that handling, preservation and storage of test equipment is such that its accuracy and fitness for purpose is maintained

When production is intermittent, the ETA-holder shall ensure that any test equipment which may be affected by the interruption is suitably checked and/or calibrated before use. The calibration of all test equipment shall be repeated if any repair or failure occurs which could upset the calibration of the test equipment.

#### 5.1.4 Testing as part of Factory Production Control

Table 8 below specifies minimum requirements for testing as part of FPC.

If constituent materials or components are supplied by other manufacturers to the ETA-holder, the supplier shall perform FPC on those constituent materials or components. If that is the case, those suppliers should submit the relevant records to the ETA-holder.

#### 5.1.5 Initial Type Testing

The assessment tests will have been conducted by the UBAtc or under its responsibility (which may include a proportion conducted by an independent laboratory or by the ETA-applicant, witnessed by the UBAtc). The UBAtc will have assessed the results of these tests in accordance with chapter 3 of this ETA, as part of the ETA issuing procedure.

**Table 8: Properties and minimum frequencies of control**

Property	Indicative test method <sup>6</sup>	Threshold value (if any)		Minimum number of Tests
		Slim	XS	
Visual aspect	visual	No defaults		1/pallet
Length	EN ISO 10545-2	± 2 mm		1/pallet
Height		± 2,5 mm		1/pallet
Thickness		± 1 mm		1/pallet
Squareness		± 3 mm		1/pallet
Flatness		± 2/3 mm*		1/pallet
straightness		± 3 mm		1/pallet
Water absorption	EN ISO 10545-3	< 9 %		1/batch
Bending strength	EN ISO 10545-4	> 15 MPa		1/batch
E-modulus	EN ISO 10545-4	> 20 N/mm <sup>2</sup>		1/batch
Freeze-thaw sensitivity	EN 539-2	passed		Twice a year

\* 2mm on the edge, 3 mm in the centre

<sup>6</sup> The ETA-holder may adopt alternative test methods provided they serve the same purpose



## 5.2 Tasks for the notified body

### 5.2.1 Certification of factory production control

#### 5.2.1.1 Initial inspection of the manufacturing plant and of factory production control

Assessment of the factory production control is the responsibility of the notified factory production control certification body.

An assessment shall be carried out of each production unit to demonstrate that the factory production control is in conformity with the ETA and any subsidiary information. This assessment shall be based on an initial inspection of the factory and of the factory production control.

#### 5.2.1.2 Continuous surveillance, assessment and evaluation of factory production control

Subsequently continuous surveillance of factory production control is necessary to ensure continuing conformity with the ETA.

It is recommended that Surveillance inspections are to be conducted at least twice a year.

## Annex 1: Figures

Smooth



Figure 1a – Piterak finish example

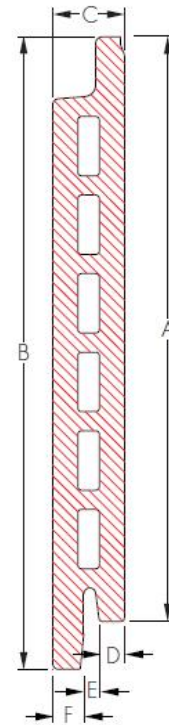
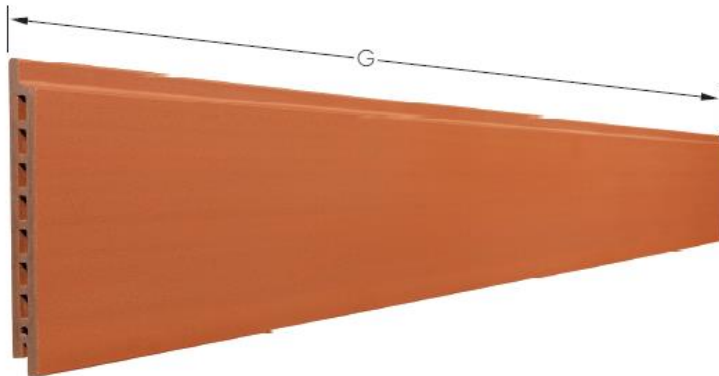

Figure 1b – Piterak tile

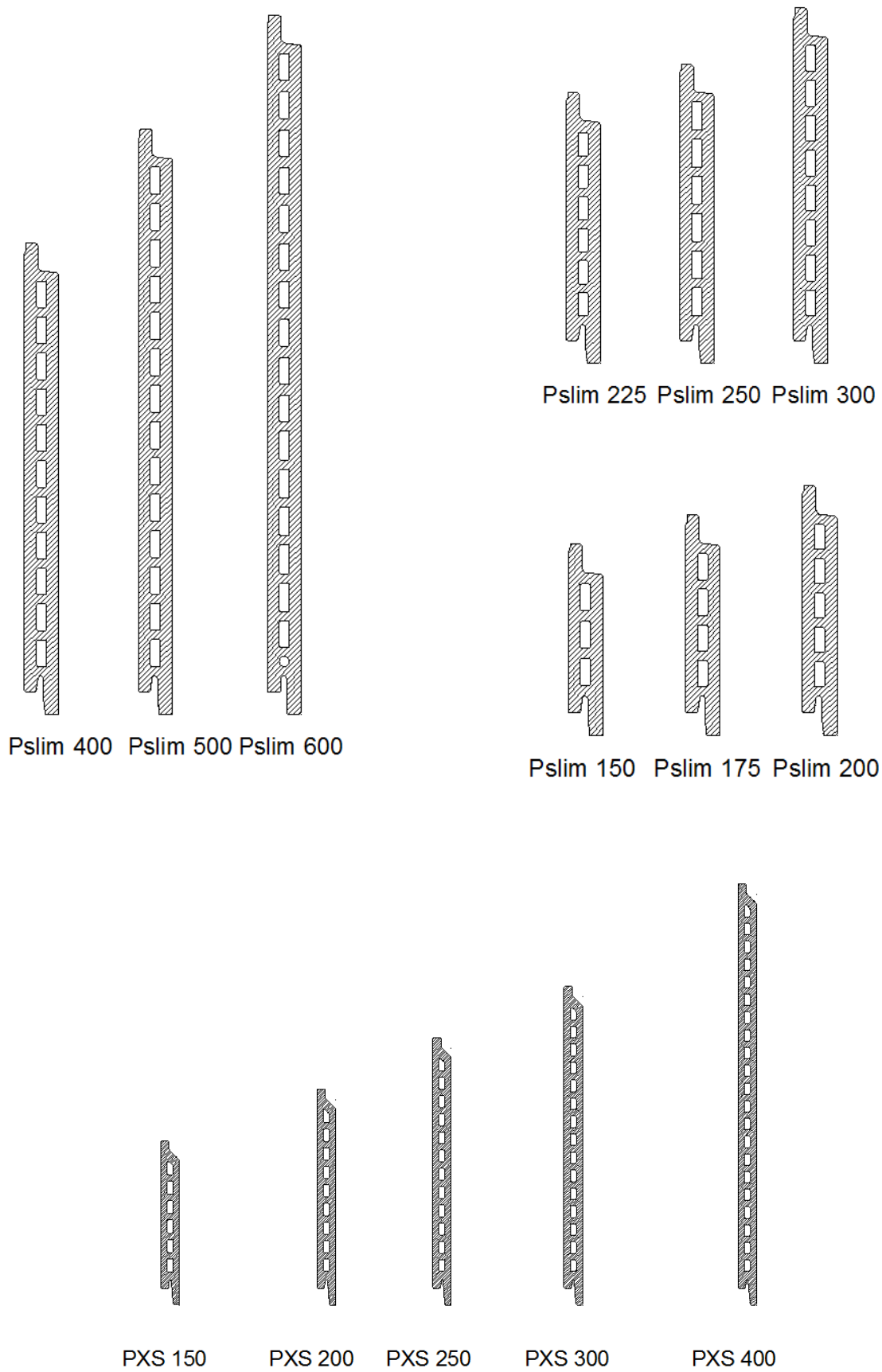
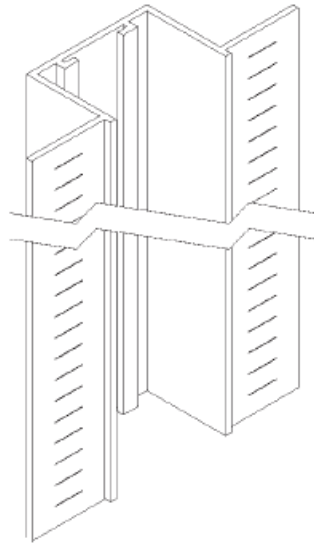
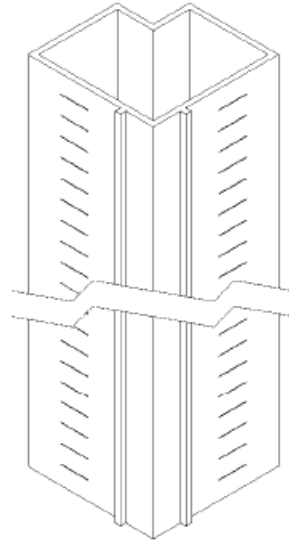

Figure 1c: Examples of Piterak profile detail



omega profile section



corner rail section

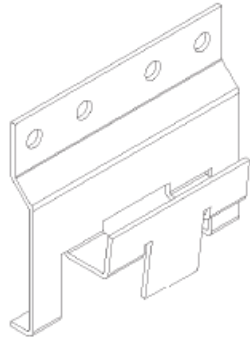

standard clip

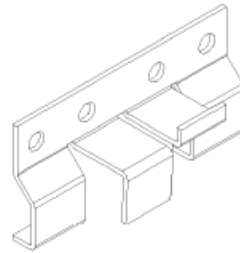

top replacement clip

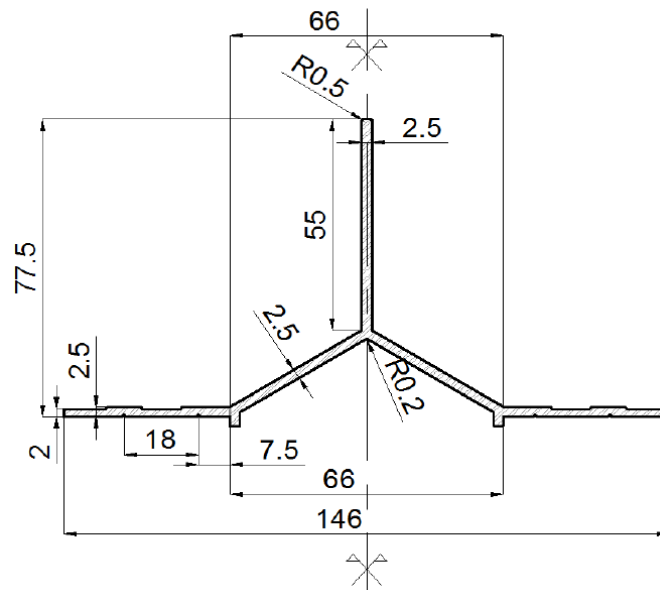

Y-profile section

Figure 2: tile support rails and support clips

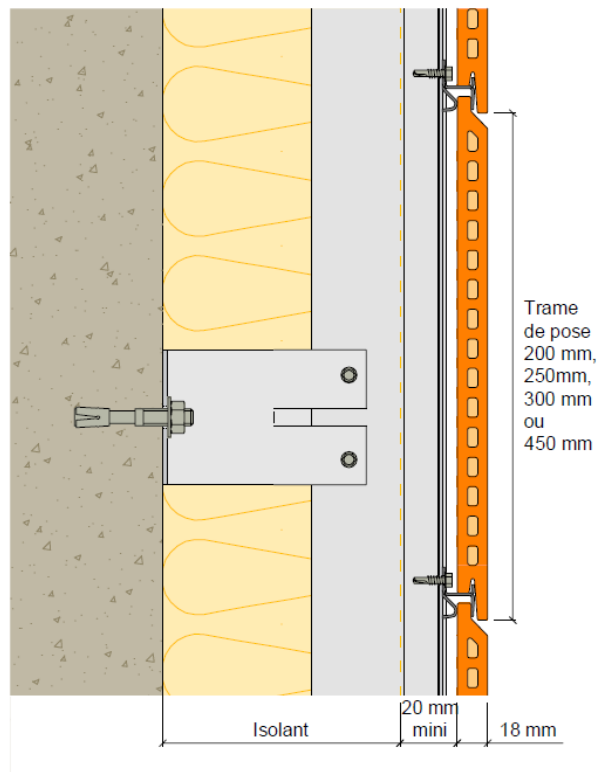
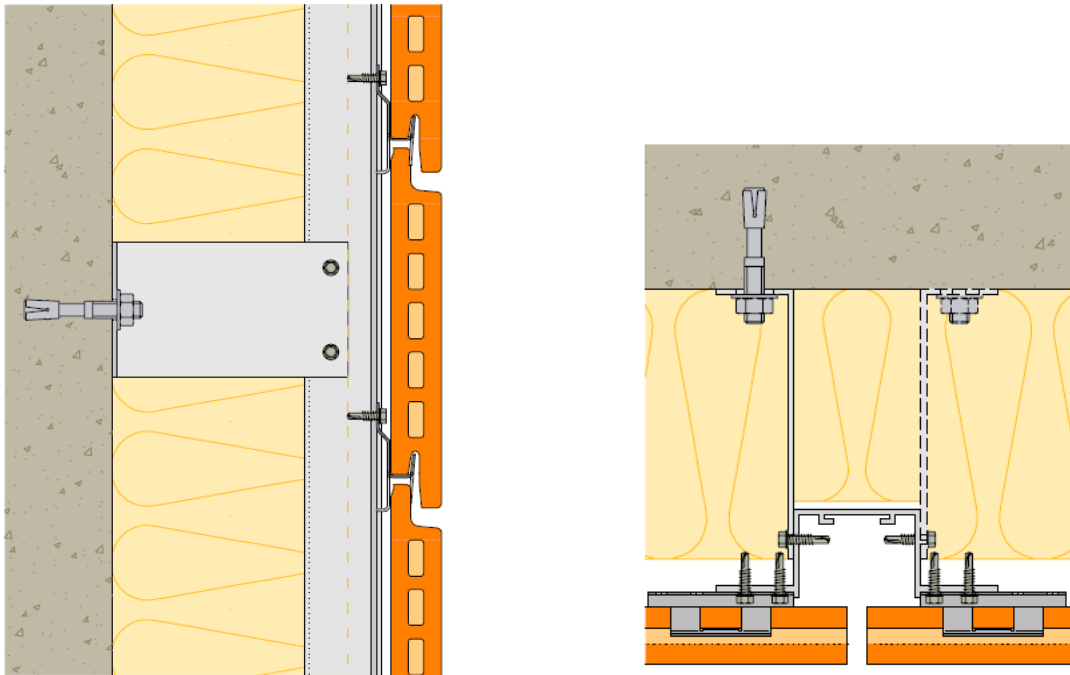

Figure 3: typical installation details (U-section)

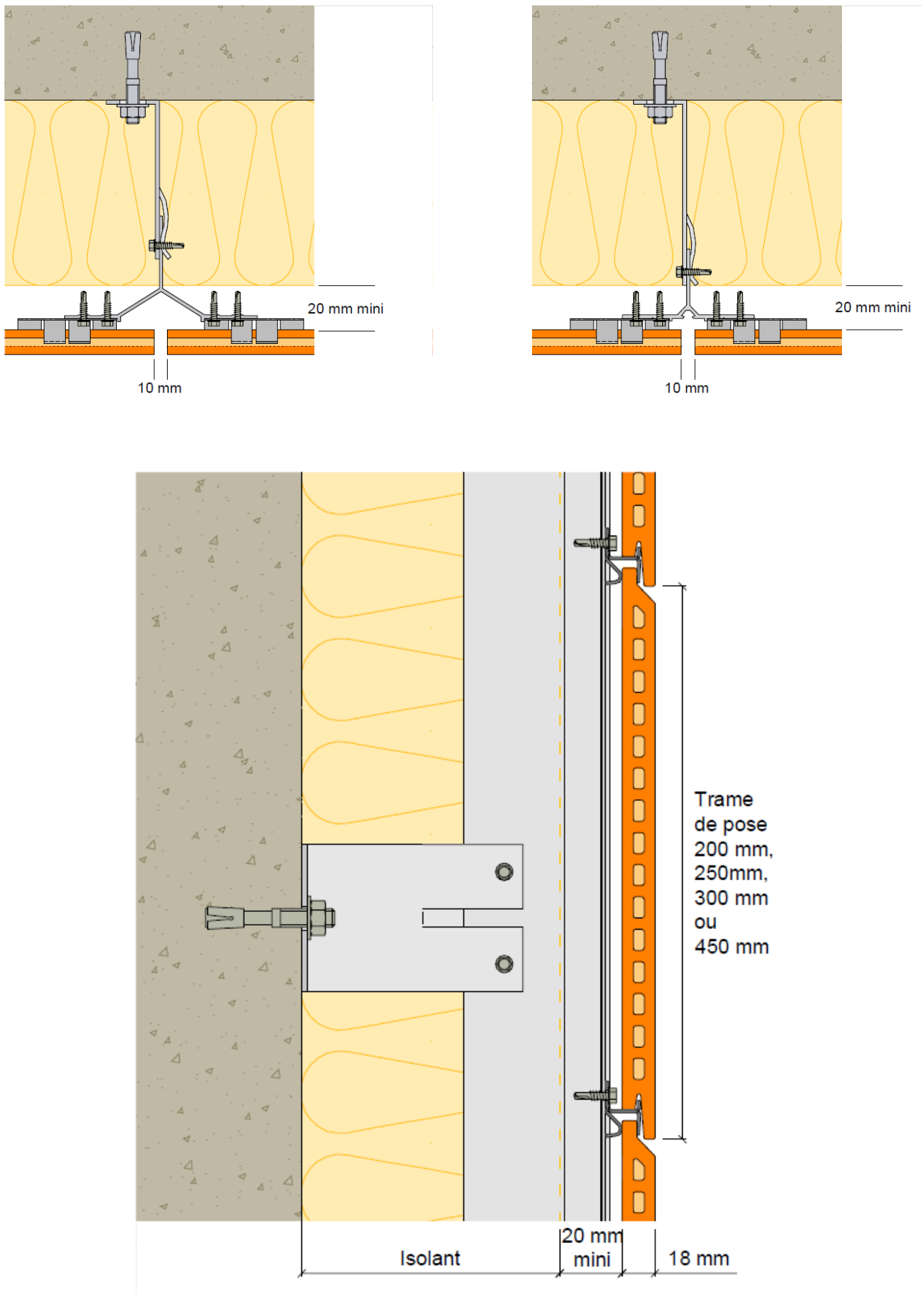

Figure 4: typical installation details (Y-section)



## Annex 2 - Requirements for rigid or semi-rigid insulation materials

Property	Test method	Mineral wool	EPS	XPS	PUR/PIR	PF	CG
Edge finishing	-	Straight	Tongued and grooved or rebate	Tongued and grooved or rebate	Tongued and grooved or rebate	Tongued and grooved or rebate	Straight
Thermal conductivity	EN 12667	$\lambda_{90/90} \leq \lambda_D$	$\lambda_{90/90} \leq \lambda_D$	$\lambda_{90/90} \leq \lambda_D$	$\lambda_{90/90} \leq \lambda_D$	$\lambda_{90/90} \leq \lambda_D$	$\lambda_{90/90} \leq \lambda_D$
Tolerance on length	EN 822	$\pm 2\%$	L1	$\pm 8$ mm (l < 1000 mm) $\pm 10$ mm (l $\geq$ 1000 mm)	$\pm 5$ mm (l < 1000 mm) $\pm 7,5$ mm (l $\leq$ 2000 mm) $\pm 10$ mm (l $\leq$ 4000 mm) $\pm 15$ mm (l > 4000 mm)	$\pm 5$ mm (l < 1250 mm) $\pm 7,5$ mm (l $\leq$ 2000 mm) $\pm 10$ mm (l $\leq$ 4000 mm) $\pm 15$ mm (l > 4000 mm)	$\pm 2$ mm uncovered  $\pm 5$ mm covered
Tolerance on width	EN 822	$\pm 1,5\%$	W1	$\pm 8$ mm (b < 1000 mm) $\pm 10$ mm (b $\geq$ 1000 mm)	$\pm 5$ mm (b < 1000 mm) $\pm 7,5$ mm (b $\leq$ 2000 mm)	$\pm 3$ mm (b < 1250 mm) $\pm 7,5$ mm (b $\leq$ 2000 mm)	$\pm 2$ mm
Tolerance on thickness	EN 823	T3, T4, T5, T6, T7	T1	T1	T2	T1, T2	$\pm 2$ mm
Squareness	EN 824	$\leq 5$ mm/m	S1	$\leq 5$ mm/m	$\leq 6$ mm/m	$S_{l,b} \leq 6$ mm/m $S_d \leq 2$ mm	$S_{l,b} \leq 6$ mm/m $S_d \leq 2$ mm
Flatness	EN 825	$\leq 6$ mm	P4	$\leq 3/5$ mm ( $\leq 75$ dm <sup>2</sup> ) $\leq 3/5/7$ mm ( $> 75$ dm <sup>2</sup> )	$\leq 5$ mm ( $\leq 75$ dm <sup>2</sup> ) $\leq 10$ mm ( $> 75$ dm <sup>2</sup> )	$\leq 10$ mm (d < 50 mm) $\leq 7,5$ mm (50 $\leq$ d $\leq$ 100 mm)	$\leq 2$ mm
Dimensional stability	EN 1604	48h 23°C 90%RV $\leq 1\%$	DS(70,90)1 $\leq 1\%$	48h 70°C 90%RV $\leq 5\%$	$\geq$ DS(TH)2	48h 70°C 90%RV $\pm 1,5\%$	48h 70°C 90%RV $\Delta\epsilon_{l,b} \leq 0,5\% / \Delta\epsilon_d \leq 1\%$
Tensile strength, parallel with the surface	EN 1608	$\geq 2$ x weight	-	-	-	-	-
Reaction to fire	EN 13501-1	A1-F	A1-F	A1-F	A1-F	A1-F	A1-F
Pressure strength	EN 826	-	$\geq$ CS (10) 60	$\geq$ CS (10\Y) 100	$\geq$ CS (10\Y) 100	$\geq$ CS (Y) 100	$\geq$ CS (Y) 400
Moisture absorption	EN 1609	$\leq 0,5$ kg/m <sup>2</sup>	-	-	-	WS4 $\leq 0,5$ kg/m <sup>2</sup>	$\leq 0,5$ kg/m <sup>2</sup>
Vapour permeability	EN 12086	Order of magnitude cf. EN ISO 10456	Tabulated values cf. EN 13163	Order of magnitude cf. EN ISO 10456	Order of magnitude cf. EN ISO 10456	Order of magnitude cf. EN ISO 10456	Order of magnitude cf. EN ISO 10456
Finishing of the borders		Straight borders	Tooth-groove or rabbet	Tooth-groove or rabbet	Tooth-groove or rabbet	Tooth-groove or rabbet	Straight borders

## 6 Reference documents

EN 539-2:2013	Clay roofing tiles for discontinuous laying - Determination of physical characteristics - Part 2: Test for frost resistance	EN ISO 9001	Quality management systems - Requirements
EN 755-2	Aluminium and aluminium alloys - Extruded rod/bar, tube and profiles - Part 2: Mechanical properties	EN ISO 10545-2	Ceramic tiles - Part 2: Determination of dimensions and surface quality
EN 13501-1	Fire classification of construction products and building elements - Part 1: Classification using data from reaction to fire tests	EN ISO 10545-3	Ceramic tiles - Part 3: Determination of water absorption, apparent porosity, apparent relative density and bulk density
		EN ISO 10545-4	Ceramic tiles - Part 4: Determination of modulus of rupture and breaking strength
		EN ISO 10545-9	Ceramic tiles - Part 9: Determination of resistance to thermal shock

UBAtc asbl is a non-profit organization according to Belgian law. It is a Technical Assessment Body notified by the Belgian notifying authority, the Federal Public Services Economy, SMEs, Self-Employed and Energy, on 17 July 2013 in the framework of Regulation (EU) N° 305/2011 of the European Parliament and of the Council of 9 March 2011 laying down harmonised conditions for the marketing of construction products and repealing Council Directive 89/106/EEC and is member of the European Organisation for Technical Assessment, EOTA ([www.eota.eu](http://www.eota.eu)).

This European Technical Assessment has been issued by UBAtc asbl on the basis of the technical work carried out by the Assessment Operator, BCCA.

On behalf of UBAtc asbl,



Peter Wouters,  
Director

On behalf of the Assessment Operator, BCCA,  
responsible for the technical content of the ETA,

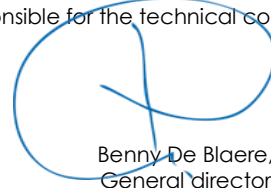

Benny De Blaere,  
General director

The most recent version of this European Technical Assessment may be consulted on the UBAtc website ([www.ubatc.be](http://www.ubatc.be)).